

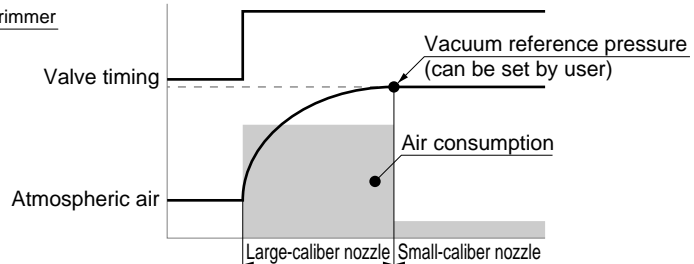

# Vacuum Generator VQ Type

Package: 1 pc. in a bag

- 31.5-mm wide vacuum generator is designed to optimize the control of large vacuum flows. Ejector system-compatible units and Vacuum pump system-compatible units are available for various needs.
- Three different types of ejector system-compatible units are available: single-nozzle type (nozzle diameter: 1.5mm, 2.0mm), two-stage nozzle type (nozzle diameter: 0.7mm, 1.0mm, 1.2mm) and twin-nozzle type.
- The twin-nozzle type, the most durable unit for extended-duration vacuum absorption/transport applications, is controlled by means of both large-and small-caliber nozzle. The former nozzle controls vacuum generation from start up to a prescribed reference level of pressure, after which the latter takes over. This combination makes possible substantial reductions in vacuum consumption (patent pending).

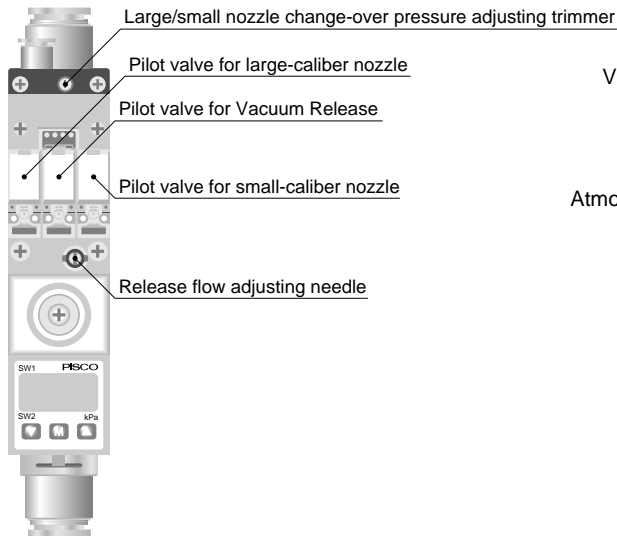

Nozzle type	Air consumption	
T15	100	17
T20	200	30

- The two-stage nozzle type's vacuum suction rate has been increased by approximately 40% compared to conventional types (PISCO Vacuum Generator comprehensive type).

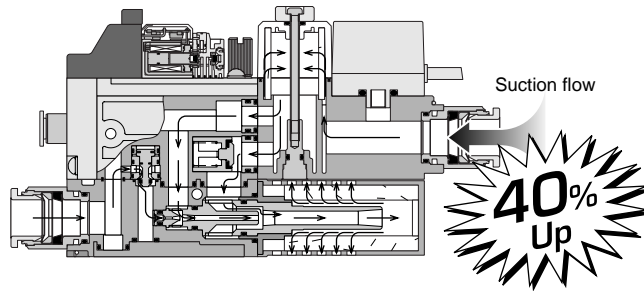

- The single-nozzle type is an orthodox, comprehensive vacuum generator designed to produce large vacuum flows.
- A wide variety of valve type is standardized:
  - Single-nozzle type: Normally open, Normally closed, Double type
  - Two-stage nozzle type: Normally open, Normally closed type
  - Twin-nozzle type: Normally closed type
  - Vacuum pump system-compatible unit: Normally open, Normally closed type
- With our pressure sensors, a high level of visual recognition (in-house comparison) has been realized - the result of a 31-mm-wide large-sized LED display.
- All settings can be made using just three push buttons.
- Four different display units are available.

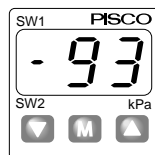

## Specifications

### Common to all VQ series vacuum generators

Unit	Ejector system-compatible unit	Vacuum pump system-compatible unit
Fluid admitted	Air	
Service pressure range	44 ~ 102psi (0.3 ~ 0.7MPa)	
Service temperature range	41 ~ 122°F (5 ~ 50°C)	
Working vacuum range	—	0 ~ -29.5in. Hg (-100 ~ 0kPa)

### Ejector characteristics

Nozzle type		Nozzle dia. (in./mm)		Pressure supply (psi/MPa)	Final vacuum (in. Hg/-kPa)	Suction flow (SCFM/min(ANR))	Air consumption (SCFM/min(ANR))		
Single nozzle	H15	0.06/1.5	—	72.5/0.5	-27.5/93 (-19.5/66)	2.22/63 3.35/95	3.53/100		
	L15								
	E15								
	H20	0.08/2.0	—			72.5/0.5	-27.5/93 (-19.5/66)	3.88/110 6.36/180	7.06/200
	L20								
	E20								
Twin nozzle	T15	0.02/0.6 (Small-caliber)	0.06/1.5 (Large-caliber)	72.5/0.5	-27.5/93 (-27.5/93)			1.41/40 (1.06/30)	3.53/100 (0.60/17)
	T20	0.03/0.8 (Small-caliber)	0.08/2.0 (Large-caliber)					2.47/70 (1.48/42)	7.06/200 (1.06/30)
2-stage nozzle	D07	0.03/0.7	—	72.5/0.5	-27.5/93			0.85/24	0.81/23
	D10	0.04/1.0	—			1.27/36	1.62/46		
	D12	0.05/1.2	—			1.41/40	2.47/70		

\*Numerical values in parentheses ( ) for twin-nozzle type vacuum generators are for small-caliber nozzle.

### Vacuum switch

Service pressure range	-29.5 ~ 29.5in. Hg (-100 ~ 100kPa)
Proof pressure	59.1in. Hg (200kPa)
Storage temperature range	-4 ~ 158°F (-20 ~ 70°C)
Operating temperature range	14 ~ 122°F (-10 ~ 50°C)
Operating humidity range	35 ~ 85%RH
Power requirements	DC12 ~ 24V ±10%, ripple P-P: 10% or less
Protective structure	IEC specification IP40-equivalent
Number of pressure-setting points	2
Switch output	NPN open collector: DC30V, 100mA or less; residual voltage: 1.2V or less (when applied with a 100mA-load current)
Differential response	0 ~ 30digit (Variable)
Accuracy of repetition	Within the range of ±0.3%F.S.
Response	5msec max.
Indication	2 1/2 digit-7-segmented LED display
No. of indications	About 4 times/sec
Indication accuracy	±1%F.S. ±1digit
Temperature characteristics	±0.3%F.S. (reference temperatures: 32 ~ 122°F (0 ~ 50°C), 77°F (25°C))

### Vacuum filter

Element material	PVF (Polyvinyl formal)
Filtering capacity	10µm
Element surface area	1507mm <sup>2</sup>
Replacement element Model Designation	VQ030B61

### Vacuum release function

Supply pressure	Vacuum release air flow
72.5psi (0.5MPa)	0 ~ 1.77SCFM (0 ~ 50 l/min(ANR))

## Solenoid valve specifications

### Pilot valve

Operating system	Direct operation	
Valve construction	Elastic seal, poppet valve	
Voltage rating	DC24V	AC100V
Allowable voltage range	DC24V ±10%	AC100V ±10%
Surge limiting circuit	Surge absorber	Bridge diode
Power consumption	0.55W	1VA
Manual operation	Push-button system of lock type	
Operational indication	Red LED lighting up when coil excitation is in operation.	

### Changing valve (Change-over valves for twin-nozzle units)

Item	Valves for small-caliber nozzles	Valves for Large-caliber nozzles	Vacuum release solenoid valve
Operating system	Pneumatic operation by pilot valve		
Valve construction	Elastic seal, poppet valve		
Valve type	N.C. (Normally closed)	N.C. (Normally closed)	N.C. (Normally closed)
Lubrication	Not required		
Effective sectional area (Cv factor)	3.5mm <sup>2</sup> (0.19)	16.5mm <sup>2</sup> (0.89)	3.5mm <sup>2</sup> (0.19)

### Changing valve (Change over valves for 2-stage nozzle units)

Item	Vacuum making solenoid valve	Vacuum release solenoid valve
Operating system	Pneumatic operation by pilot valve	
Valve construction	Elastic seal, poppet valve	
Valve type	N.C. (Normally closed), N.O. (Normally open)	N.C. (Normally closed)
Lubrication	Not required	
Effective sectional area (Cv factor)	3.5mm <sup>2</sup> (0.19)	3.5mm <sup>2</sup> (0.19)

### Changing valve (Change-over valves for single nozzle units)

Item	Vacuum making solenoid valve	Vacuum release solenoid valve
Operating system	Pneumatic operation by pilot valve	
Valve construction	Elastic seal, poppet valve	
Valve type	N.C. (Normally closed), N.O. (Normally open), Double solenoid	N.C. (Normally closed)
Lubrication	Not required	
Effective sectional area (Cv factor)	16.5mm <sup>2</sup> (0.89)	3.5mm <sup>2</sup> (0.19)
Min. excitation time	50msec or more	

### Changing valve (Change-over valves for vacuum pump system-compatible units)

Item	Vacuum making solenoid valve	Vacuum release solenoid valve
Operating system	Pneumatic operation by pilot valve	
Valve construction	Elastic seal, poppet valve	
Valve type	N.C. (Normally closed), N.O. (Normally open)	N.C. (Normally closed)
Lubrication	Not required	
Effective sectional area (Cv factor)	16.5mm <sup>2</sup> (0.89)	3.5mm <sup>2</sup> (0.19)

Vacuum Actuator Tube Diaphragm Valve

# Vacuum Generator VQ Type

## Model Designation of ejector system-compatible unit (Example)

VQ **T15** **C** - **O** **O** **S** - **D24** - **S**

① ② ③ ④ ⑤ ⑥ ⑦

### ①. Vacuum characteristics, Nozzle diameter

Code	Nozzle dia. (in./mm)	Pressure supply (psi/MPa)	Final vacuum (in. Hg/kPa)	Suction flow (SCFM/l/min/ANR)	Air consumption (SCFM/l/min/ANR)
Single nozzle type	<b>H15</b> $\phi 0.06/\phi 1.5$	72.5/0.5	-275/93	2.22/63	3.53/100
	<b>L15</b> $\phi 0.06/\phi 1.5$		-195/66	3.35/95	
	<b>E15</b> $\phi 0.06/\phi 1.5$	50.8/0.35	-272/92	1.48/42	2.47/70
	<b>H20</b> $\phi 0.08/\phi 2.0$	72.5/0.5	-275/93	3.88/110	7.06/200
	<b>L20</b> $\phi 0.08/\phi 2.0$		-195/66	6.36/180	
	<b>E20</b> $\phi 0.08/\phi 2.0$	50.8/0.35	-272/92	2.97/84	5.30/150
Twin-nozzle type	<b>T15</b> $\phi 0.02/\phi 0.6$ (Small-caliber) $\phi 0.06/\phi 1.5$ (Large-caliber)	72.5/0.5	-275/93	1.41/40 (1.06/30)	3.53/100 (0.06/17)
	<b>T20</b> $\phi 0.03/\phi 0.8$ (Small-caliber) $\phi 0.08/\phi 2.0$ (Large-caliber)		-275/93	2.47/70 (1.48/42)	7.06/200 (1.06/30)
2-stage nozzle type	<b>D07</b> $\phi 0.03/\phi 0.7$	72.5/0.5	-275/93	0.85/24	0.81/23
	<b>D10</b> $\phi 0.04/\phi 1.0$		-275/93	1.27/36	1.62/46
<b>D12</b> $\phi 0.05/\phi 1.2$	-	-	1.41/40	2.47/70	

\*The vacuum characteristics in ( ) value for Twin-nozzle type is the value when small-caliber is operated.

### ②. Valve type

**C**: Normally closed type

**O**: Normally open type

**D**: Double solenoid type (retention type)

\*1: "Normal-close (code: C)" only when a twin-nozzle type is selected in ①.

\*2: "Normal-close (code: C)" or "normal-open (code: O)" only when a 2-stage nozzle type is selected in ①.

### ③. Vacuum (V) port size

Code	<b>8</b>	<b>O</b>
Tube dia. (mm)	$\phi 8$ tube fitting	$\phi 10$ tube fitting

\*Pilot valve's exhaust port is fitted with a  $\phi 6$ mm quick-fitting joint.

### ④. Air supply (PS) port size

Code	<b>6</b>	<b>8</b>	<b>O</b>
Tube dia. (mm)	$\phi 6$ tube fitting	$\phi 8$ tube fitting	$\phi 10$ tube fitting

### ⑤. Exhaust (R) method

	Open to air type	Concentrated exhaust type
Code	<b>S</b>	<b>J</b>
Tube dia. (mm)	-	$\phi 12$ tube fitting

### ⑥. Pilot valve type

Code	<b>D24</b>	<b>A100</b>
Voltage	24VDC	100VAC

\*As for twin-nozzle type, only 24VDC type is available.

### ⑦. Vacuum switch (NPN Open collector)

Code	Specifications for vacuum switch
<b>S</b>	<input type="checkbox"/> 31 mm-width 2-point output vacuum switch
<b>No code</b>	Without vacuum switch

## Model Designation of vacuum pump system-compatible unit (Example)

VQP **C** - **O** **O** - **D24** - **S**

① ② ③ ④ ⑤

### ①. Vacuum supply valve

**C**: Normally closed type

**O**: Normally open type

### ②. Vacuum (V) port size

Code	<b>O</b>	<b>2</b>	<b>3</b>
Tube dia. (mm)	$\phi 10$ tube fitting	$\phi 12$ tube fitting	$\phi 16$ tube fitting

### ③. Vacuum supply (PV) port size

Code	<b>O</b>	<b>2</b>	<b>3</b>
Tube dia. (mm)	$\phi 10$ tube fitting	$\phi 12$ tube fitting	$\phi 16$ tube fitting

\*Pilot valve's exhaust port and air supply port are each fitted with a  $\phi 6$ mm quick-fitting joint.

### ④. Pilot valve type

Code	<b>D24</b>	<b>A100</b>
Voltage	24VDC	100VAC

### ⑤. Vacuum switch (NPN Open collector)

Code	Specifications for vacuum switch
<b>S</b>	<input type="checkbox"/> 31 mm-width 2-point output vacuum switch
<b>No code</b>	Without vacuum switch

## Detailed Safety Instructions

Before using the PISCO device, be sure to read the "Safety Instructions", "Common Safety Instructions for Products Listed in This Manual" on page 15 to 17 and "Common Safety Instructions for Vacuum" on page 139 to 140.

### ⚠ Warning

1. With VQ series vacuum generators, the range of working temperature is limited to 41~122°F (5~50°C). Do not use VQ series vacuum generators in any other temperature range.
2. Heat will be generated in the coil when electricity is supplied continuously to the pilot valve for an extended period of time. As this can cause burns and possibly have adverse impacts to peripheral equipment, we recommend that the user consult the nearest PISCO sales office in cases when electricity must be supplied to the pilot valve for a prolonged period of time.
3. With double-solenoid types, the switch-over valve (main valve) is placed in neutral after the supply of pilot air has been suspended (the same is true when the valve is being operated for the first time after shipment). When resuming the supply of pilot air, be sure to send a signal to the pilot valve, or conduct switch-over operations manually as required.
4. When operating valves, confirm that leak currents are 1mA or less. Using valves with leak currents exceeding said value may lead to errors.
5. The vacuum retention capability of vacuum pump system-compatible units has been designed to tolerate some leaking. We therefore recommend that additional appropriate safety measures be taken when the state of vacuum is to be retained for a prolonged period of time.
6. Do not use these units in environments containing corrosive substances (airborne or otherwise).
7. Our products are not explosion proof. Do not use these units in environments containing flammable and/or explosive gases and/or liquids, since doing so could cause fires and/or explosions.
8. Do not use these units in temperature ranges which exceed the prescribed range of working temperatures. Operating them in heat-generating temperature ranges can cause the built-in sensors to malfunction.
9. When wiring, be sure to 1) switch OFF the power, and 2) confirm the color of each lead wire, terminal numbers, etc. in order to prevent the output terminal from being inadvertently short-circuited with the power source and the common-use terminals. Short-circuiting these terminals can be cause sensor-related problems.

### ⚠ Caution

1. Compressed air contains various drains (water, oxidized oils, tar and other foreign matter). Because these drains considerably lower product quality, we recommend that the quality of compressed air be improved by dehumidifying it via a cooler or dryer.
2. Do not use lubricators.
3. Rust, dirt and other foreign matter left in the pipes can cause malfunctions. We therefore recommend that a filter of 5µm or less be placed in front of and close to the supply port. Flushing the interior of the piping prior to operation and/or at regular intervals is also recommended.
4. Do not pull or bend valve and vacuum switch lead wires excessively. Doing so may result in lead wires being snapped off and connector components broken.
5. Do not use any vacuum units in corrosive and/or flammable gaseous environments. Do not use this equipment for the handling of fluids.
6. Our vacuum units are not constructed to be drip- or dust-proof. As such, do not use any vacuum units which have been exposed to water, oil and/or dust.
7. Do not allow vacuum generators to take in dust, salt and/or iron powders.
8. Do not operate vacuum release valves while a vacuum is being generated.
9. When replacing supply ports and vacuum ports cartridges, be sure to remove any foreign matter sticking to cartridge seals; make sure cartridge fixing pins are properly inserted into the appropriate ports.
10. Use the shortest pipes possible when piping vacuum components (concentrated exhaust, pilot air exhaust and supply units). Using long pipes can prevent vacuum units from performing properly.
11. For power, use stable direct currents.
12. Insert surge-absorbing circuits into relays, valves, etc. that are connected to the output terminals, power source terminals, etc. Do not arbitrarily use vacuum units at currents that exceed rated levels.
13. When using unit power sources, such as switching power sources, be sure to ground their FG terminals.
14. Take the utmost care to avoid short-circuiting the output terminal with other terminals.
15. Do not apply excessive loads to vacuum generators. Subjecting them to excessive loads can damage the equipment.
16. Do not wire nozzles and other components in a way that will subject them to impressed pressure. Do not use them in an arbitrary manner, either. Applying impressed pressure to vacuum components and/or using them arbitrarily can cause malfunctions.
17. In case of using twin-nozzle type, please set pressure allowance between the vacuum level at work suction time and the setting value of Large/Small nozzle change-over pressure sensor. If these values are similar, the Large/Small caliber pilot valve might actuate simultaneously.

# Vacuum Generator VQ Type

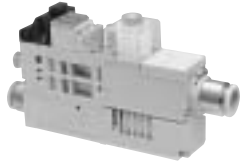
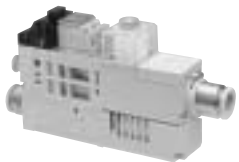
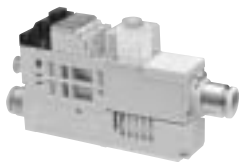
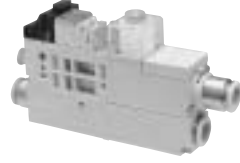
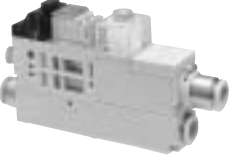
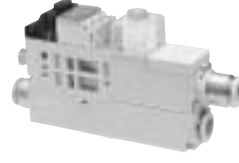
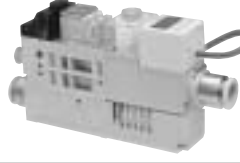
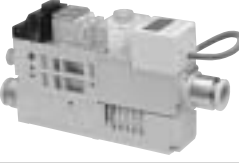
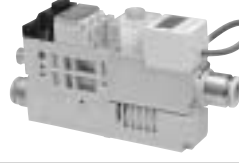
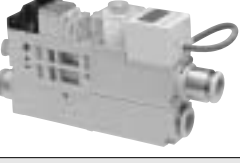
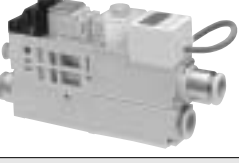
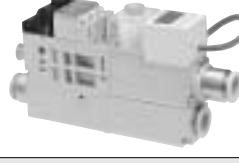
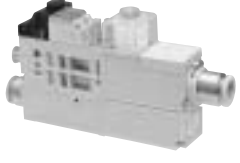
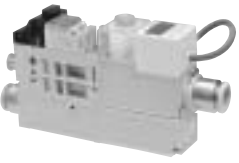
Ejector system-compatible unit		
Single nozzle type	2-stage nozzle type	Twin-nozzle type
<b>VQ</b> Without vacuum switch, Open to air 	<b>VQD</b> Without vacuum switch, Open to air 	<b>VQT</b> Without vacuum switch, Open to air 
Model	Model	Model
VQ□□-□□S-□□	VQD□□-□□S-□□	VQT□C-□□S-□□
<b>VQ</b> Without vacuum switch, Concentrated exhaust 	<b>VQD</b> Without vacuum switch, Concentrated exhaust 	<b>VQT</b> Without vacuum switch, Concentrated exhaust 
Model	Model	Model
VQ□□-□□J-□□	VQD□□-□□J-□□	VQT□C-□□J-□□
<b>VQ</b> □31-mm width 2-point output port-fitted vacuum switch, Open to air 	<b>VQD</b> □31-mm width 2-point output port-fitted vacuum switch, Open to air 	<b>VQT</b> □31-mm width 2-point output port-fitted vacuum switch, Open to air 
Model	Model	Model
VQ□□-□□S-□S	VQD□□-□□S-□S	VQT□C-□□S-□S
<b>VQ</b> □31-mm width 2-point output port-fitted vacuum switch, Concentrated exhaust 	<b>VQD</b> □31-mm width 2-point output port-fitted vacuum switch, Concentrated exhaust 	<b>VQT</b> □31-mm width 2-point output port-fitted vacuum switch, Concentrated exhaust 
Model	Model	Model
VQ□□-□□J-□S	VQD□□-□□J-□S	VQT□C-□□J-□S
Vacuum pump system-compatible unit		
<b>VQP</b> Without vacuum switch 	<b>VQP</b> □31-mm width 2-point output port-fitted vacuum switch 	
Model	Model	
VQP□□□-□□	VQP□□□-□S	

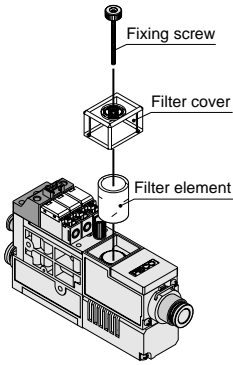
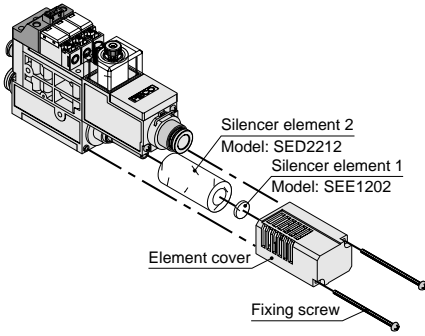
Filter element for replacement	Silencer element for replacement
 <p>Fixing screw</p> <p>Filter cover</p> <p>Filter element</p>	 <p>Silencer element 2 Model: SED2212</p> <p>Silencer element 1 Model: SEE1202</p> <p>Element cover</p> <p>Fixing screw</p>
<p>Model Designation</p>	<p>Model Designation</p>
<p>VQ030B61</p>	<p>SED2212-SET *The element set includes SED2212 and SEE1202.</p>